

环保型光敏传感器
Environmentally friendly photosensitive sensor
产品规格书
Product specifications

客户名称 Customer	
日期 Date	
产品型号 Model	LLS03-D ML 黑色
产品单号 Product number	

制作 Make	梁广进
核准 Approval	
客户承认签名 Customer Signatures	

销售中心

Sales center

地址：中国 深圳市 南山区 梦海大道 5109 号 卓越前海壹号 T3 座 32 层

Address: 32nd Floor, Tower T3, One Excellence, No.5109 Menghai Avenue, Nanshan District, Shenzhen, China

主页 Website: www.nysenba.com

电话 Tel: 86-755-82594756 18929323299

传真 Fax: 86-755-82594762

■ 产品功能

Product function

1. 替代传统光敏电阻 (CdS)，不含镉、铅等有害物质，符合欧盟 ROHS 标准
Replace Photoresistors(Cds),RoHS Compliance/Pb-free/Cd-free.
2. 自动调节背景光，如 LCD，手机，照相机，电脑摄像头等
adjust background light automatically,LCD,mobile phone,camera,Computer Camera etc.
3. 适用于各种光控照明产品和光控玩具：如小夜灯等
Suitable for all kinds of light control products and light control toys,such as night lamp etc.
4. 适用于各种红外监控类产品
Applicable to all kinds of infrared monitoring products

■ 产品特性

Product Features

1. 峰值感光波长520nm
Peak sensitive wavelength 520nm
2. 低功耗
Low Power Consumption
3. 高可靠性
High reliability
4. 批量一致性好，完全解决灯起动过早或一致性不好等现象
Perfect consistency, completely solve the problems of early start or poor consistency of the lamp.
5. 响应速度快，性能稳定，+85℃高温/65%高湿条件下老化1000H起动点不漂移
Fast response, stable performance, no drift at 1000h starting point under + 85 °C/ 65% humidity condition
6. 可按要求提供不同外型尺寸，方便安装于产品的任何位置
Size customized, easy for Installation.

■ 产品外观尺寸图 Product Dimensions

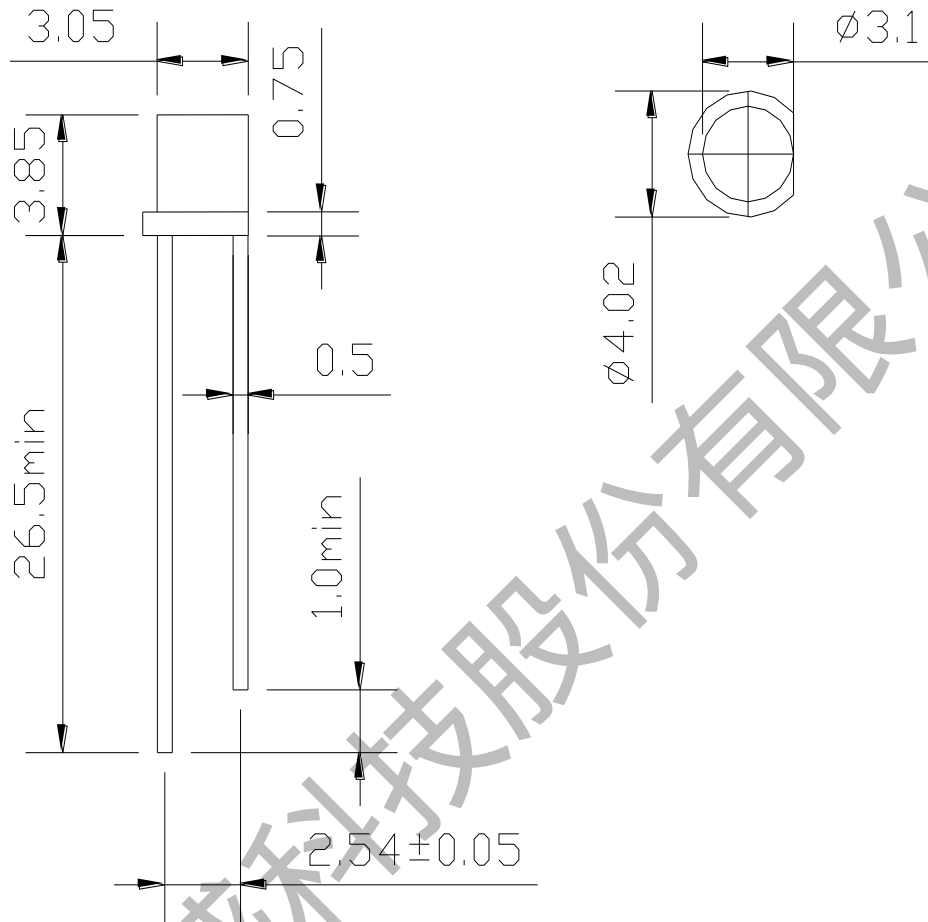

注 Note:

1. 长脚负极（发射极） 短脚正极（集电极）
Long pin-Emitter Short pin-Collector
2. 所有尺寸为毫米（mm），未指定公差为：±0.15mm
Unit: mm ± 0.15mm
3. 胶体外观颜色以样品实物为准
The appearance color of colloid shall be subject to the sample
4. 胶体下沿突出树脂最大为1.0mm
Protruded resin under the base is 1.0mm maxium.

■ 最大额定值 (Ta=25℃) MAXIMUM RATING (TA = 25 ° C)

参数名称 Parameter name	符号 Symbol	额定值 Rating	单位 Unit
集电极-发射极电压 Collector-Emitter Voltage	V_{CEO}	20	V
发射极-集电极电压 Emitter-Collector Voltage	V_{ECO}	5	V
功耗 Consumption	P_C	70	mW
工作温度 Working temperature	T_{opr}	-25~+85	°C
储存温度 Storage temperature	T_{stg}	-40~+100	°C

■ 光电特性 (Ta=25℃) ELECTOR-OPTICAL CHARACTERISTICS (TA = 25 ° C)

参数名称 Parameter	符号 Symbol	测试条件 Testing conditions	最小值 Min.	典型值 Typical Value	最大值 Max.	单位 Units
光电流 Photo-current	$I_L(1)$	$V_{DD}=5V, E_V=10Lux$	5	10	18	μA
	$I_L(2)$	$V_{DD}=5V, E_V=50Lux$	~	50	~	μA
	$I_L(3)$	$V_{DD}=5V, E_V=100Lux$	~	100	~	μA
暗电流 Dark current	I_{CEO}	$V_{DD}=5V, E_V=0Lux$	~	~	0.2	μA
感光峰值波长 Photosensitive peak wavelength	λ_p	\		520		nm
感光波长范围 Sensitivity wave range	λ_d	\	450	~	700	nm
集电极-发射极电压 Collector-emitter Breakdown Voltage	$B_{V_{CEO}}$	$I_C=100\mu A$ $E_e=0mW/cm^2$	~		70	V
发射极-集电极电压 Emitter-Collector Breakdown Voltage	$B_{V_{ECO}}$	$I_E=10\mu A$ $E_e=0mW/cm^2$	~		30	V
集电极发射极饱和电压 Collector-Emitter saturation voltage	$V_{ce(sat)}$	$I_C=2mA$ $E_e=1mW/cm^2$	~		0.4	V
响应时间 Response time	开启时间 Rise time	$V_{CE}=5V,$ $I_C=1mA$ $R_L=10k\Omega$	10			μs
	关闭时间 Fall time		15			

注：测试光源采用 2850K 色温 LED.

Notes: The test light source adopts 2850k color temperature led

■ 测试原理图 Test schematic

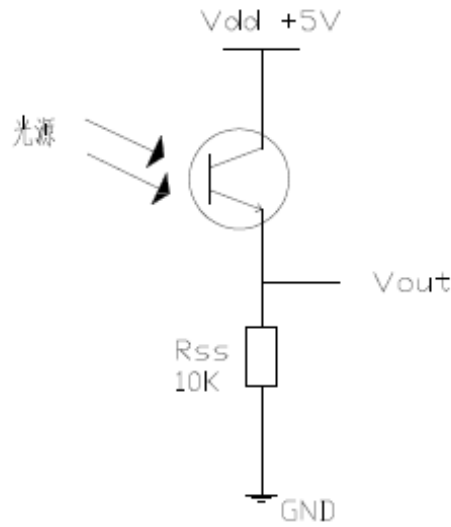

光电流 Photocurrent = V_{out} / R_{ss}
 * R_{ss} 推荐使用高稳定电阻。
 High stable resistance is recommended for R_{SS}

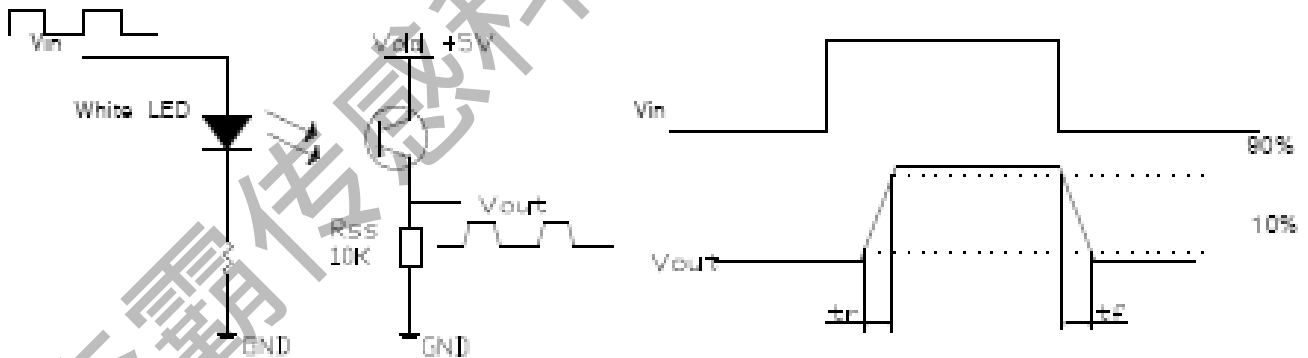

开关时间测量方法 Measurement method of switching time

参考电路 Reference circuit

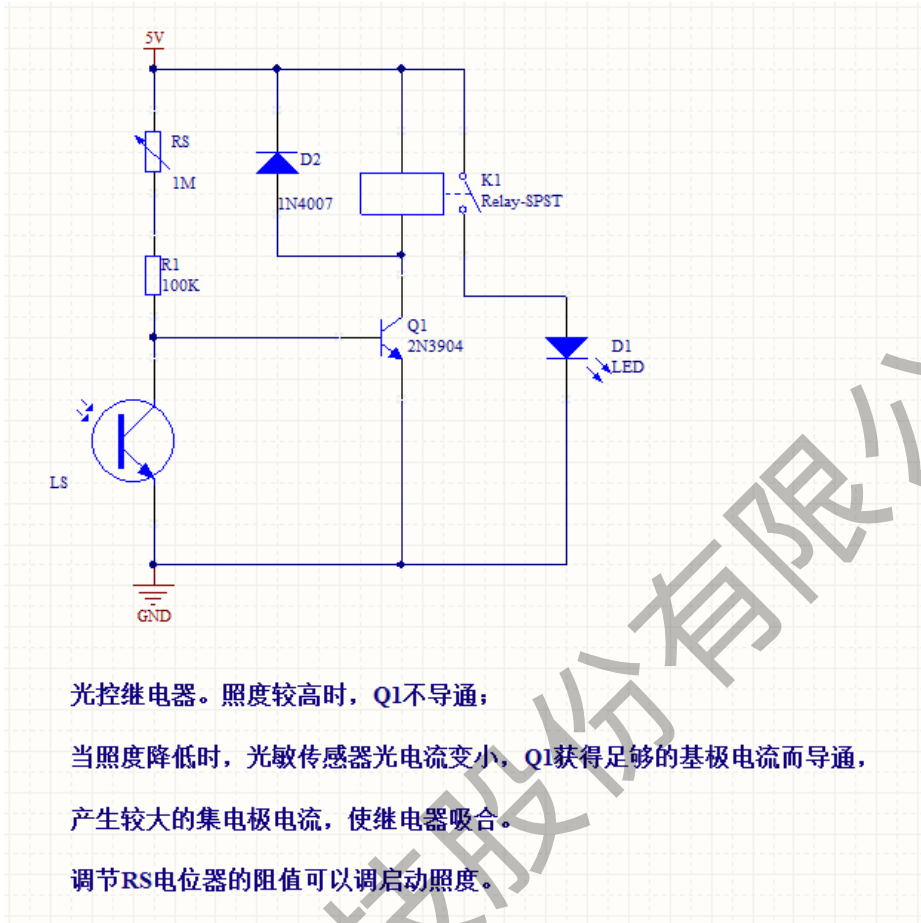

光控继电器。照度较高时，Q1不导通；
当照度降低时，光敏传感器光电流变小，Q1获得足够的基极电流而导通，
产生较大的集电极电流，使继电器吸合。
调节RS电位器的阻值可以调启动照度。

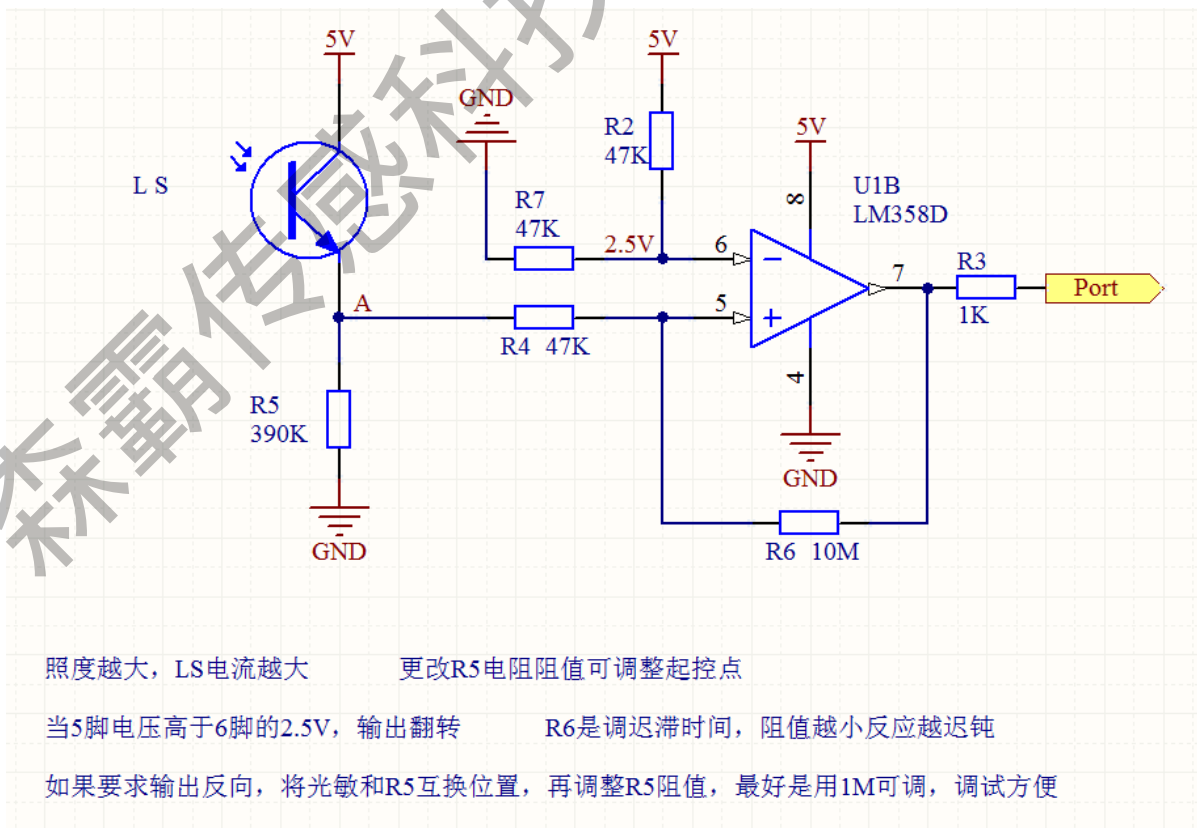

照度越大，LS电流越大 更改R5电阻阻值可调整起控点
当5脚电压高于6脚的2.5V，输出翻转 R6是调迟滞时间，阻值越小反应越迟钝
如果要求输出反向，将光敏和R5互换位置，再调整R5阻值，最好是用1M可调，调试方便

■ 光电特性曲线 Typical photoelectric characteristics curves

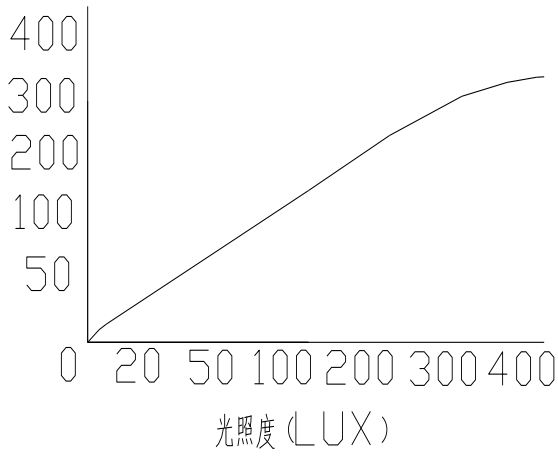

光照度与光电流变化图
Change of illuminance and photocurrent

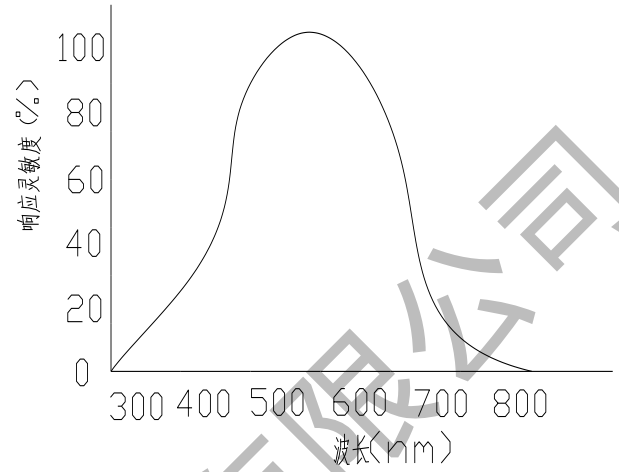

感光波长图
Photowavelength map

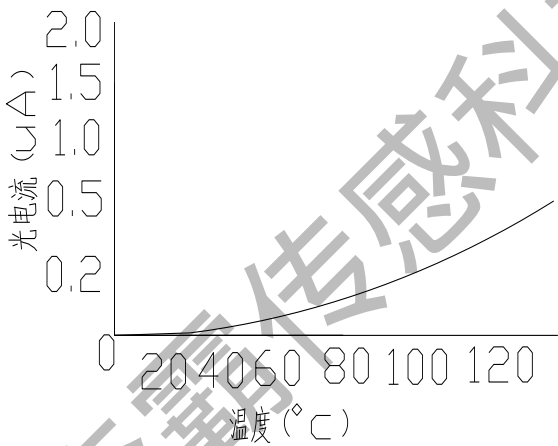

温度与亮电流变化图
Temperature and photocurrent diagram

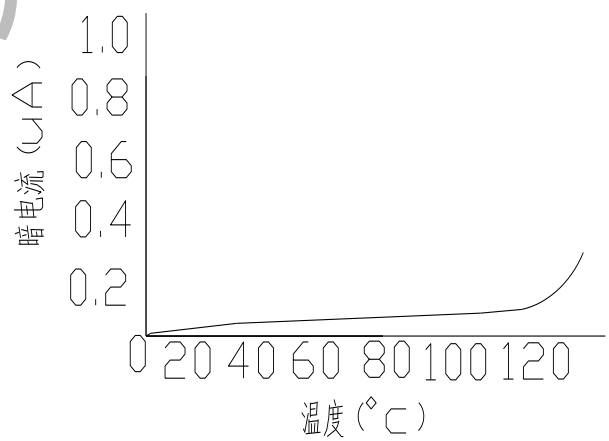

温度与暗电流变化图
Temperature and dark current diagram

■ 可靠性实验 Reliability Test

测试项目 Test Parameter	参考标准 Reference Criterion	测试条件 Test Condition	时间 Time	样品数 Quantity	允收/ 拒收 Ac/RE
耐焊接热 Resistance to Solder Heat	JESD22-B106	260°C±5°C	10sec	30PCS	0/1
冷热循环 Thermal Cycle	JESD22-A104	+110°C(15min) 5min -15°C(15min)	50 cycles	30PCS	0/1
冷热冲击 Thermal Shock	JESD22-A104	+120°C(30min) -45°C(30min)	50 cycles	30PCS	0/1
高温存储 High Temperature storage	JESD22-A103	+100°C	1000H	30PCS	0/1
低温存储 Low Temperature storage	JESD22-A119	-40°C	1000H	30PCS	0/1
高温高湿 High Temperature and High Humidity Test	JESD22-A101	90°C & 85%R.H	168H	30PCS	0/1
寿命测试 Life Test	JESD22-A108	VCE=5V	1000H	30PCS	0/1

■ 推荐焊接条件 Recommended Soldering Conditions

焊接模式 Mode		条件 Condition
手工焊接 Manually Soldering	烙铁温度 Soldering Iron Temperature	最高温度 340℃ (功率最大 60 瓦) Max340℃(power:60Wmax)
	焊接时间 Soldering Time	时间不超过 3 秒 ≤3 seonds
	焊接位置 Soldering Position	大于 1.5mm (从焊点到胶体) 1.5mm Min.(Form soldering joint to colloid)
波峰焊接 Wave Soldering	预热 Preheat	最高温度 110℃ 不超过 80 秒 110℃ Max.80 sec.Max.
	温度 Temperature	最高 260℃ ≤260℃
	焊接时间 Soldering Time	不超过 5 秒 ≤5 seonds
锡炉焊接 Solder pot Soldering	预热 Preheat	最高温度 100℃ 不超过 60 秒 100℃ Max.60 sec.Max
	浸焊温度 Preheat Temperature	最高 260℃ ≤260℃
	浸焊时间 Soldering Time	不超过 5 秒 ≤5 seonds
	焊接位置 Soldering Posiion	大于 1.5mm (从焊点到胶体) >1.5mm(Form soldering joint to colloid)

注 Notes:

焊接过程中的不慎操作将会引起产品的损坏。焊接过程中应避免对产品支架或封装部分施加压力。
Careless operation in the welding process will cause product damage. During the welding process, any pressure on the product bracket or package part shall be avoided.

■ 使用注意事项 Precautions

1. 该产品出厂后贮存的条件应为 $0\sim+30^{\circ}\text{C}$ ，相对湿度不大于 70%，贮存期限为 3 个月，若贮存超过 3 个月，则应放在带有氮气或干燥剂的封闭容器中，贮存时间可长达一年

The storage conditions of the product after leaving the factory shall be 0 to $+30^{\circ}\text{C}$, the relative humidity shall not be more than 70%, and the storage period shall be 3 months. If the storage period is more than 3 months, the product shall be placed in a closed container with nitrogen or desiccant, and the storage period may be up to one year

2. 一旦打开包装后，应尽可能短时间内使用完，若用不完，应立即封口，贮存条件 $0\sim+30^{\circ}\text{C}$ ，相对湿度 $\leq 60\%$ ，并在一周内用完。

Once the package is opened, the products should be used up as soon as possible. If it is not used up, it should be sealed immediately. The storage condition is $0\sim+30^{\circ}\text{C}$, and the relative humidity $\leq 60\%$. It should be used up within one week

3. 产品支架是铁合金表面上镀银，银表面会受到腐蚀性气体等环境的影响，应避免使产品处于易腐蚀的环境中，这会导致产品焊接异常。

The product support is silvered on the surface of ferroalloy. The silver surface will be affected by corrosive gas and other environment. It should be avoided to make the product in a corrosive or tarnished environment, which will affect the welding performance.

4. 清洗产品时推荐使用酒精作为清洗剂，如使用其它清洗剂，须先确认清洗剂是否会腐蚀环氧胶体，任何情况下，清洗时间不超过 1 分钟。

It is recommended to use alcohol as cleaning agent when cleaning products. If other cleaning agents are used, it is necessary to confirm whether the cleaning agent will corrode the epoxy gel. In any case, the cleaning shall be completed within 1 minute

5. 本产品为静电敏感器件，所有静电和电涌会损坏产品，要求使用时佩戴防静电腕带，所有的装置、设备、机器、桌子、地面都必须防静电接地

This product is an electrostatic sensitive device. All static electricity and surge will damage the product. It is required to wear anti-static wrist strap when operating. All devices, equipments, machines, tables and ground must be anti-static grounded